

OS1

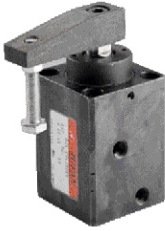

Features

- Dimensions of the body for OS1 square clamp cylinders are the same as JUFAN'S compact hydraulic cylinders.
- OS1 square clamp cylinders is the most powerful clamp device in OS product family.
- Sensor and proximity switches can be applied on the OS1 product for signal sensing and controlling.

Theoretical force

bore (mm)	bore (mm)	pressed piston area (cm ²)	clamp force(kgf)	
			70kgf/cm ²	140kgf/cm ²
32	20	4.9	343	686
40	20	9.4	658	1316
50	25	14.7	1029	2058
63	25	26.2	1834	3668

Spec.

bore(mm)	32	40	50	63
motion	double acting			
swivel angle	90°, 180°			
swivel direction	left(L) or right(R)			
swivel stroke	16	20		
clamp stroke(mm)	9	10		
fluid(mm)	midinal			
working pressure(kgf/cm ²)	70 ~ 140			
test(kgf/cm ²)	210			

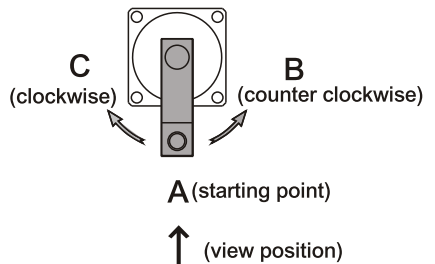

L:left turn with counter clockwise direction:

A:starting point
B:clamping point

R:right turn with clock wise direction :

A:starting point
B:clamping point

Standard stroke

bore angle		32	40	50	63
90°	L				
	R				
180°		no standard			

Structures and part names

item	part name	q'ty
①	tube	1
②	rod	1
③	rod cover	1
④	piston	1
⑤	guide pin	1
⑥	clamp arm	1
⑦	rod dust seal	1
⑧	rod packing	1
⑨	cover o-ring	1
⑩	piston o-ring	1
⑪	piston back-up ring	2
⑫	piston o-ring	1
⑬	hex.bolt	1
⑭	hex.nut	1
⑮	clamp bolt	1
⑯	clamp holder	1
⑰	set screw	1

Seal spec.

name \ bore	⑦ rod dust seal		⑧ rod packing		⑨ cover o-ring		⑩ piston o-ring		⑪ piston back-up ring		⑫ piston o-ring	
	type	q'ty	type	q'ty	type	q'ty	type	q'ty	type	q'ty	type	q'ty
32	DH20	1	UHS20	1	G40	1	P26	1	P26	2	P16	1
40	DH20	1	UHS20	1	G45	1	P34	1	P34	2	P16	1
50	DH25	1	UHS25	1	G50	1	P44	1	P44	2	P21	1
63	DH25	1	UHS25	1	G55	1	P53	1	P53	2	P21	1

Order form

OS1 — SR — SD — 32 × 90
 ① — ② — ③ — ④

OS1 : Square swivel and clamp cylinders		
①	type	(1)SR : single side right swivel (3)DR : double sides right swivel (2)SL : single side left swivel (4)DL : double sides left swivel
②	mounting	(1)SD : basic (2)FB : head flange
③	bore(mm)	32、40、50、63
④	swivel angle	90°、180°

External dimensions

● OS1 SD basic 90° single arm													● OS1 SD basic 90° double arms												
note bore	A	B	C	D	E	EE	F	G	H	HA	HB	I	J	K	L	M	P	MM	R	S	U	UL	W		
φ 32	172	97	16	24	φ 45	RC1/4"	47	62	6.8	11	6.5	15	55	15	25	M10×1.5	45	20	11	10	M8×1.25	16	25		
φ 40	173	98	16	24	φ 48	RC1/4"	52	70	8.6	14	8.6	15	60	15	25	M10×1.5	45	20	11	10	M10×1.5	20	25		
φ 50	205	110	26	28	φ 55	RC1/4"	58	80	8.6	14	8.6	20	65	20	30	M12×1.75	50	25	11	10	M10×1.5	20	28		
φ 63	213	118	26	28	φ 65	RC1/4"	69	94	14	20	13	20	70	20	30	M12×1.75	50	25	11	10	M16×2.0	30	28		

note : If a through hole is needed for either φ 40 or φ 50, H dimension should be changed from φ 8.6mm to φ 9.0mm for this special need. Please notice sales department for it .

GENTLE AUTOMATIC SOLUTION SDN BHD

No.36, Jalan Industri USJ 1/13, Taman Perindustrian USJ 1, 47600 Subang Jaya, Selangor.

TEL: 603-8023 7743 / 8743 FAX: 603-8023 9743

email:sales@gentle.com.my

External dimensions

● OS1 FB head flange 90° single arm

● OS1 FB head flange 90° double arm

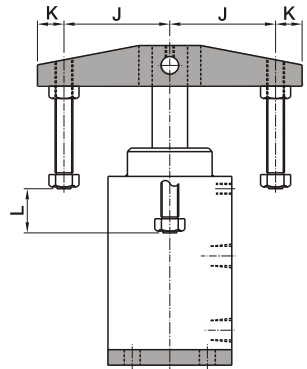
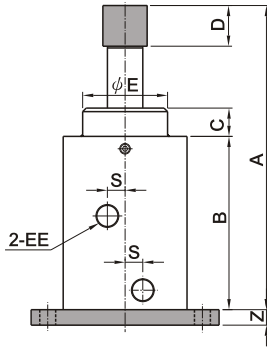
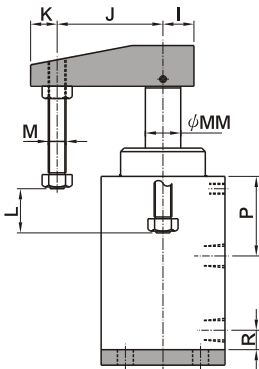
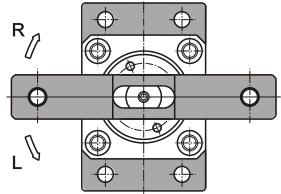
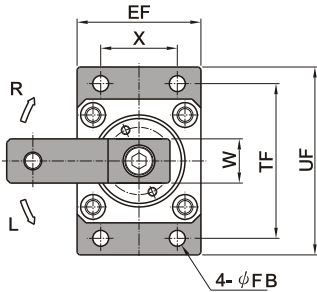

note bore	A	B	C	D	E	EE	I	J	K	L	M	P	R	S	MM	W	X	TF	EF	UF	Z	FB
φ 32	172	97	16	24	φ 45	RC1/4"	15	55	15	25	M10×1.5	45	11	10	20	25	40	88	63	109	11	11
φ 40	173	98	16	24	φ 48	RC1/4"	15	60	15	25	M10×1.5	45	11	10	20	25	46	95	69	118	11	11
φ 50	205	110	26	28	φ 55	RC1/4"	20	65	20	30	M12×1.75	50	11	10	25	28	58	115	85	145	14	14
φ 63	213	118	26	28	φ 65	RC1/4"	20	70	20	30	M12×1.75	50	11	10	25	28	65	132	102	165	15	18

GENTLE AUTOMATIC SOLUTION SDN BHD

No.36, Jalan Industri USJ 1/13, Taman Perindustrian USJ 1, 47600 Subang Jaya, Selangor.

TEL: 603-8023 7743 / 8743 FAX: 603-8023 9743

email:sales@gentle.com.my