

KP30 SERIES

Features

- Setting pressure range : Compound (-100.0~100.0 kPa)
Vacuum (10.0~-101.3 kPa)
Positive (-0.100~1.000 MPa)
- 2 outputs & analog output (1~5V)
- Hysteresis adjustable
- Programmable pressure unit :
kPa · MPa · kgf/cm² · bar · psi · inHg · mmHg · mmH₂O



SPECIFICATIONS

TYPE	Compound	Vacuum	Positive
MODEL	KP30C	KP30V	KP30P
Rated pressure range	-100.0 ~ 100.0 kPa	0.0 ~ -101.3 kPa	0.000 ~ 1.000 MPa
Setting pressure range	-100.0 ~ 100.0 kPa	10.0 ~ -101.3 kPa	-0.100 ~ 1.000 MPa

FEATURES HIGHLIGHT

1 Programmable pressure unit

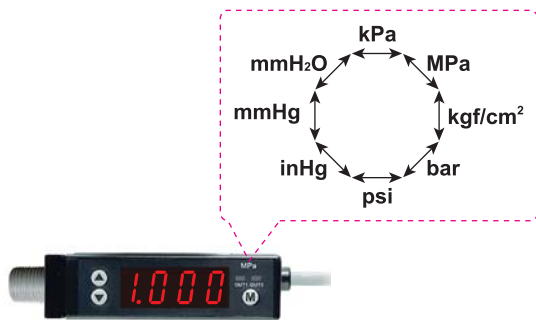

2 Key lock function

Key lock mode to prevent unauthorized adjustments
Press (M) more than 5 seconds to enter key lock mode
Use ▲ or ▼ to select key lock status

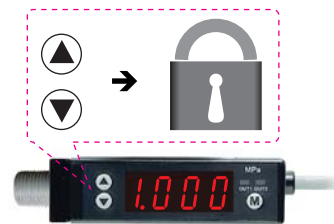

3 Analog output

2 outputs & analog output (1~5V)
Output range 1 to 5V, proportional to the pressure range

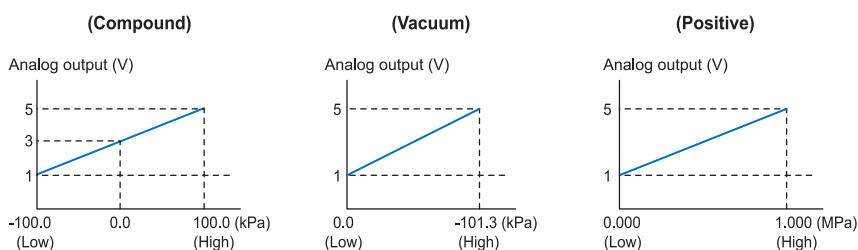

4 Hysteresis adjustable

Output hysteresis (H) is adjustable by user

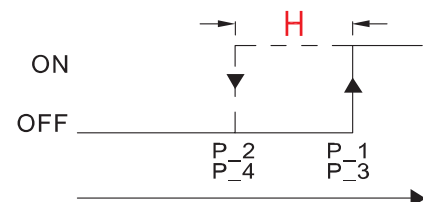

■ SPECIFICATIONS

MODEL		KP30C (Compound)	KP30V (Vacuum)	KP30P (Positive)
				
Rated pressure range		-100.0 ~ 100.0 kPa	0.0 ~ -101.3 kPa	0.000 ~ 1.000 MPa
Setting pressure range		-100.0 ~ 100.0 kPa	10.0 ~ -101.3 kPa	-0.100 ~ 1.000 MPa
Withstand pressure		300 kPa		1.5 MPa
Fluid		Filtered air, Non-corrosive/Non-flammable gas		
Set pressure resolution	kPa	0.1		-
	MPa	-		0.001
	kgf/cm ²	0.001		0.01
	bar	0.001		0.01
	psi	0.01		0.1
	inHg	0.1		-
	mmHg	1		-
	mmH ₂ O	0.1		-
Power supply voltage		12 to 24V DC ±10%, Ripple (P-P) 10% or less		
Current consumption		≤ 60mA		
Switch output		NPN : open collector 2 outputs Max. load current : 80mA Max. supply voltage : 30V DC Residual voltage : ≤ 1V		PNP : open collector 2 outputs Max. load current : 80mA Max. supply voltage : 24V DC Residual voltage : ≤ 1V
Repeatability(Switch output)		±0.2% F.S. ±1 digit		
Hysteresis	Hysteresis mode	Adjustable		
	Window comparator mode	Fixed (3 digits)		
Response time		≤ 2.5ms (chattering-proof function: 24ms, 192ms and 768ms selectable)		
Output short circuit protection		Yes		
7 segment LED display		3 ½ digit LED display (Sampling rate: 5 times/1sec.)		
Indicator accuracy		±2% F.S. ±1 digit (Ambient temperature: 25 ±3°C)		
Indicator		OUT1 = Green, OUT2 = Red		
Analog output (Only type KP30□-01 □, KP30□-03 □)		Output voltage : 1 to 5V ±5% F.S. (within rated pressure range) Linearity : ±1% F.S.	Output voltage : 1 to 5V ±2.5% F.S. (within rated pressure range) Linearity : ±1% F.S.	
Environment	Enclosure	IP 40		
	Ambient temp. range	Operation : 0 ~ 50°C, storage : -20 ~ 60°C (No condensation or freezing)		
	Ambient humidity range	Operation/Storage : 35 ~ 85% RH (No condensation)		
	Withstand voltage	1000V AC in 1-min (between case and lead wire)		
	Insulation resistance	50MΩ (at 500V DC, between case and lead wire)		
	Vibration	Total amplitude 1.5mm, 10Hz-55Hz-10Hz scan for 1 minute, two hours each direction of X, Y and Z		
Shock		980m/s ² (100G), 3 times each in direction of X, Y and Z		
Temperature characteristic		±2% F.S. of detected pressure (25°C) at temp. Range of 0~50°C		
Port size		F1:R1/8", M5 ; F2:NPT1/8", M5 ; F3:G1/8"(BSPP), M5		
Lead wire		Oil-resistance cable (0.15mm ²)		
Weight		Approx. 67g (with 2 meter lead wire), Approx. 35g (with M8 4Pin male connector)		

■ INSTALLATION PRECAUTIONS

- When mounting, always use the wrench on the metallic area near the pressure port. Never apply a wrench to the plastic body, it will damage the sensor.
- Over tightening may cause damages to the port thread, mounting bracket and pressure sensor. Under tightening may result loosen or leakage.
- Apply pressure and power after installation and make necessary adjustments and inspect any possible signs of leakage to ensure proper installation.

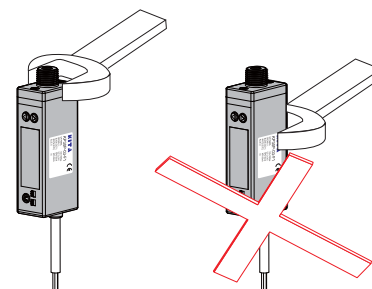

KP30 SERIES

■ PANEL DESCRIPTION

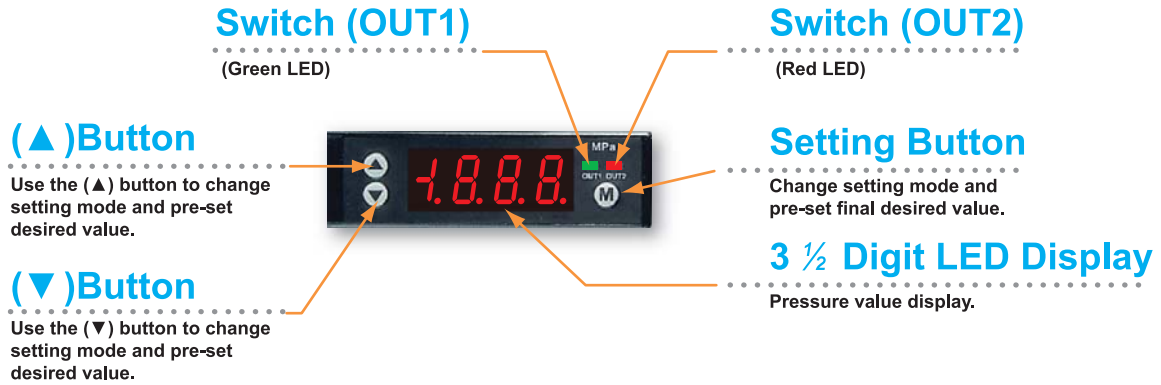

■ OUTPUT CIRCUIT WIRING DIAGRAMS

KP30 □ - 01 - □ - □
NPN Output & Analog Output

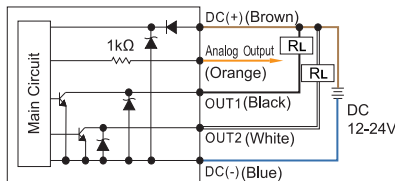

KP30 □ - 02 - □ - □
NPN Output

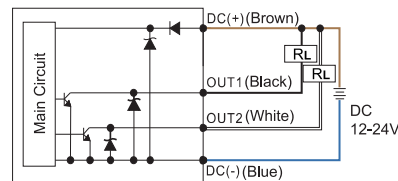

KP30 □ - 03 - □ - □
PNP Output & Analog Output

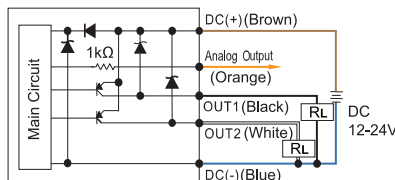

KP30 □ - 04 - □ - □
PNP Output

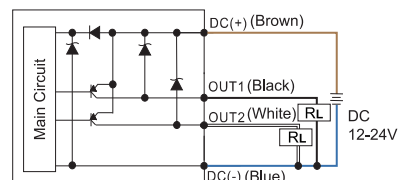

■ ORDERING INFORMATION

K P 3 0 C - 0 1 - F 1 - □

Pressure Range

C : Compund (-100.0~100.0 kPa)
V : Vacuum (10.0~101.3 kPa)
P : Positive (-0.100~1.000 MPa)

Pressure Port

F1 : R1/8", M5
F2 : NPT1/8", M5
F3 : G1/8"(BSP), M5

Output Specification

01 : 2 NPN output & Analog output(1~5V)
02 : 2 NPN output
03 : 2 PNP output & Analog output(1~5V)
04 : 2 PNP output

Cable Length / Connector

Blank : With 2 meter cable
QD : With M8 4Pin male connector
*(Only type KP30 □ - 02 - □, KP30 □ - 04 - □)

Optional Part

M8 4Pin female connector



■ M84R-W0085-2M

Optional Part

M84R-W0085-2M : M8 4Pin female connector

GENTLE AUTOMATIC SOLUTION SDN BHD

No. 36 Jalan Industri USJ 1/13, Taman Perindustrian USJ 1, 47600 Subang Jaya, Selangor.

TEL: 603-8023 7743 / 8743 FAX: 603-8023 9743 email: sales@gentle.com.my

■ DIMENSIONS

KP30□-□-□

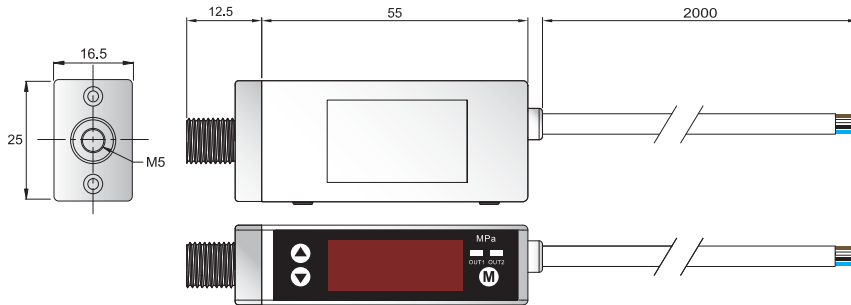

KP30□-□-□- QD

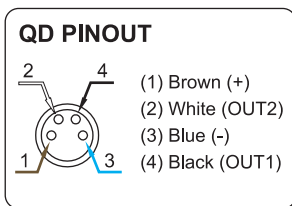
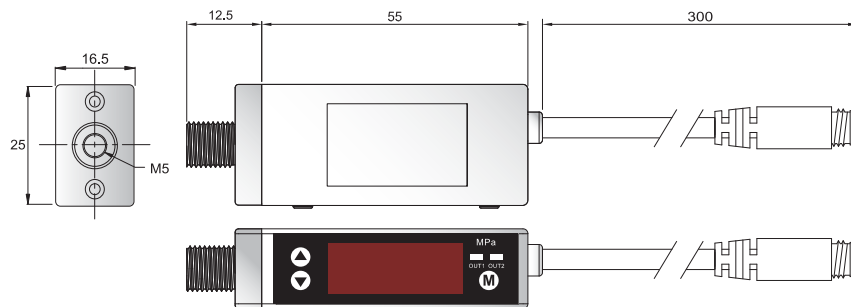

■ OPTIONAL PART DIMENSIONS

M8 Female Connector model : M84R-W0085-2M

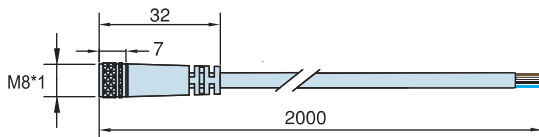

Unit:mm